



# Architectural Trims

*The Choice of Professionals*

Catalogue Edition 3





***The Choice of Professionals***

Trims are an essential element in delivering a professionally finished project and DTA Trims are the recognised industry standard. Many DTA trims are manufactured in Australia using local and imported materials, while others are fully imported. Regardless of whether a trim is manufactured here or imported, DTA ensure they market and maintain the highest quality product standards. DTA's market leadership is the result of a quality product range developed through consultation with the trade in Australia and internationally. Through extensive research in both European and Asian markets, DTA are able to offer a range of trims in suitable materials, that satisfy the most demanding customer applications. Most DTA trims will be in stock at retailers, or supplied from the DTA state warehouses. More specialised profiles can be supplied with a phone call to a DTA state office.

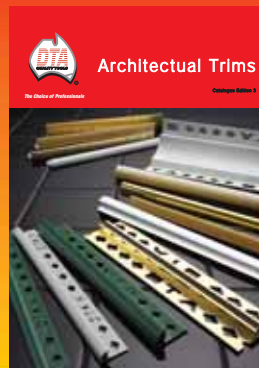
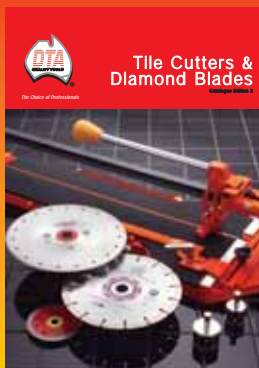

# Architectural Trims

<b>DTA TRIM MANUFACTURING</b>	2
<b>ROUND EDGE TRIM</b>	
PVC Round Edge Trim	3
Aluminium Round Edge Trim	4
Brass Round Edge Trim	4
Stainless Steel Round Edge Trim	5
Aluminium Round Corner Edge Trim	5
<b>SQUARE EDGE TRIM</b>	
Aluminium/PVC Square Edge Single Leg Trim	6
Aluminium Square Edge Double Leg Trim	7
Stainless Steel Square Edge Trim	7
<b>LISTELLO TRIM</b>	
Aluminium Listello Trim	8
<b>L-SHAPE TRIM</b>	
Aluminium L-Shape Trim	9
Brass L-Shape Trim	10
Stainless Steel L-shape Trim	11
<b>TRANSITION TRIM</b>	
Aluminium Transition Edge Trim	12
<b>STEP EDGE TRIM</b>	
Aluminium Step Edge Trim	13
<b>CARPET TRIM</b>	
Aluminium Carpet Trim	13
<b>COVE TRIM</b>	
PVC Cove Trim	14
Aluminium Cove Trim	15
Aluminium Cove Corners	16
Aluminium All Purpose Cove Trim	17
<b>MOVEMENT JOINTS</b>	
PVC Movement Joints	18
PVC Screed Movement Joint	18
Aluminium Movement Joints	19
Brass Movement Joint	19
Stainless Steel Movement Joint	20
<b>TRIMS MERCHANDISING MATERIAL</b>	21



# DTA Trim Manufacturing and Distribution

DTA manufacture in Australia and import tile trims from all over the world. DTA select the best and most appropriate profiles and materials to ensure you the customer gets the best possible trim at the right cost for your application. DTA Trim manufacture is carried out at DTA's Chelsea Heights headquarters and is quality checked and dispatched to customers all over Australia. Materials used are brass, aluminium, stainless steel and PVC. DTA always welcome customer feedback in developing new trim products and recommended usages.

## Benefits of Various Materials



**STAINLESS STEEL**  
*Grade 304 and 316L (Marine Grade)*  
*Ideal for coastal areas*

Highly recommended for public and high traffic areas due to mechanical strength and chemical resistance. It is used in many architectural and technical applications.



**BRASS**  
*Grade C380*

Brass is an elegant material and is highly regarded by architects and interior designers. It is best for indoor applications. It is best suited to indoor application. It has a warm gold colour.



**ALUMINIUM**  
*Grade 6063T5 (Plain & Anodised)*  
Aluminium has a wide variety of applications and is sought after for range of profiles and complex shapes, lightweight, ductility and ease of cutting and use. Also DTA offer many variants of finish, including bright and matt colour anodising.



**PVC**  
*UV Stabilised*

A remarkably versatile material that has found wide ranging applications in many building projects because of its corrosion resistance. Available in many designer colours. It is economical and easy to use. Not recommended for external use.

Whatever your requirement we feel there will be a DTA trim that is perfect for the application. Please contact DTA Australia to discuss your needs.

### Handy Hints

Always remove excess grout immediately after grouting to avoid discolouration.

# PVC ROUND EDGE TRIM



External Corner Trim - Horizontal



External Corner Trim - Vertical



Finishing Trim

- PVC round edge trim.
- Professional looking quadrant finish.
- Highest grade PVCU construction.
- Use with all tile types.
- Available in 17 fashionable colours.

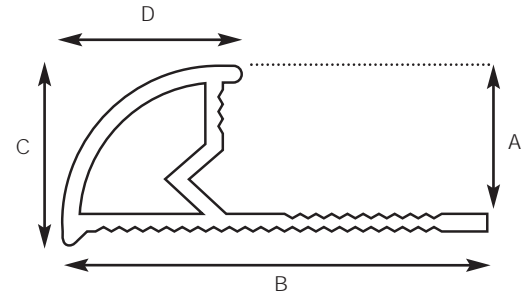

Size A	B	C	D
6mm	22mm	8mm	8mm
8mm	23mm	11mm	10mm
10mm	27mm	12mm	11mm
12mm	31mm	15mm	9mm

**DIY/TRADE**

PVC Trim x 2.5metre		6mm	8mm	10mm	12mm*	Pack	Price List
Colour		Code	Code	Code	Code	Qty	Page
White		TT625W	TT825W	TT1025W	TT1225W	100	
Ivory		TT625IY	TT825IY	TT1025IY	TT1225IY	100	
Vanilla		TT625V	TT825V	TT1025V	TT1225V	100	
Apricot		TT625A	TT825A	TT1025A	TT1225A	100	
Peach		TT625P	TT825P	TT1025P	TT1225P	100	
Beige		TT625BE	TT825BE	TT1025BE	TT1225BE	100	
Grey		TT625GY	TT825GY	TT1025GY	TT1225GY	100	
Green		TT625GN	TT825GN	TT1025GN	TT1225GN	100	
Black		TT625BK	TT825BK	TT1025BK	TT1225BK	100	
Travertine		TT625T	TT825T	TT1025T	TT1225T	100	
Havana		TT625H	TT825H	TT1025H	TT1225H	100	
Jasmine		TT625J	TT825J	TT1025J	TT1225J	100	
Mocha		TT625M	TT825M	TT1025M	TT1225M	100	
Alabaster		TT625JA	TT825JA	TT1025JA	TT1225JA	100	
Ultra White		TT625JUW	TT825JUW	TT1025JUW	TT1225JUW	100	
J/Vanilla		TT625JV	TT825JV	TT1025JV	TT1225JV	100	
J/White		TT625JW	TT825JW	TT1025JW	TT1225JW	100	

\*Please note 12mm only available in a pack quantity of 80.

# ALUMINIUM/BRASS ROUND EDGE TRIM

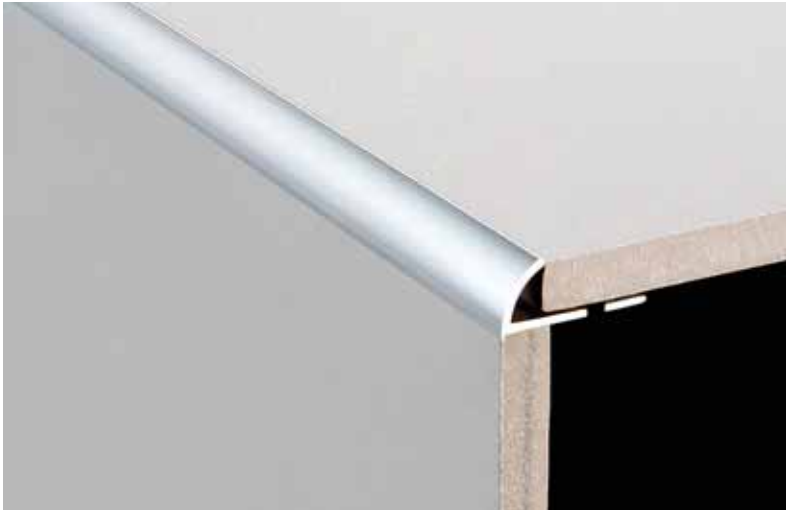

External Corner Trim - Horizontal



External Corner Trim - Vertical



Finishing Trim

- Semi-quadrant finish for tile edge protection.
- Designed for wall and external corner applications.
- Creates an elegant look.
- Available in a large range of anodised and power coated colours (customised colours available on request).
- Also available in Brass.

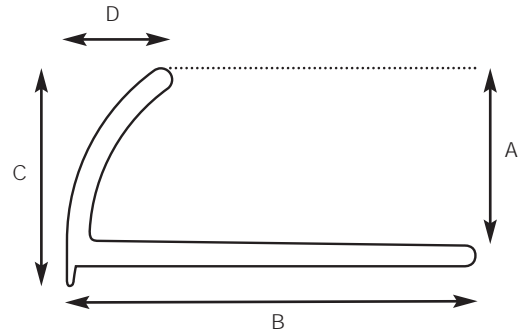

Size A	B	C	D
6mm	22mm	8.5mm	4.2mm
8mm	22mm	10.5mm	6.2mm
10mm	23mm	12.5mm	6.2mm
12mm	23mm	15mm	6.0mm

**DIY/TRADE**

Aluminium Round Edge x 2.5metre		6mm	8mm	10mm	12mm	Pack	Price List
Colour		Code	Code	Code	Code	Qty	Page
Plain		ARE25.6	ARE25.8	ARE25.10	ARE25.12	20	
Matt Silver		ARE25.6MS	ARE25.8MS	ARE25.10MS	ARE25.12MS	20	
Bright Silver		ARE25.6BS	ARE25.8BS	ARE25.10BS	ARE25.12BS	20	
Bright Gold		ARE25.6BG	ARE25.8BG	ARE25.10BG	ARE25.12BG	20	
Matt Black		ARE25.6MBL	ARE25.8MBL	ARE25.10MBL	ARE25.12MBL	20	
Matt Bronze		ARE2.6MBR	ARE25.8MBR	ARE25.10MBR	ARE25.12MBR	20	
White		ARE25.6W	ARE25.8W	ARE25.10W	ARE25.12W	20	



External Corner Trim - Vertical



Finishing Trim

See diagram above.

Size A	B	C	D
6mm	22mm	7.5mm	4mm
8mm	22mm	9.5mm	6.7mm
10mm	23mm	11.5mm	7.5mm
12mm	23mm	14mm	6.7mm

**DIY/TRADE**

Brass Round Edge x 2.5metre		6mm	8mm	10mm	12mm	Pack	Price List
Colour		Code	Code	Code	Code	Qty	Page
Brass		PABRE25.6	PABRE25.8	PABRE25.10	PABRE25.12	20	

# STAINLESS STEEL ROUND EDGE TRIM & ALUMINIUM ROUND CORNER EDGE TRIM



External Corner Trim - Horizontal



External Corner Trim - Vertical



Finishing Trim

- Stainless Steel Semi Quadrant Round Edge creates an elegant decorative external corner.
- Can be used on:
  - ✓ Stairs ✓ Bath Hobs ✓ External corners Horizontal or Vertical ✓ Finishing trim on a wall
- Available in both 304 grade and Marine 316L.
- Available in 4 sizes.

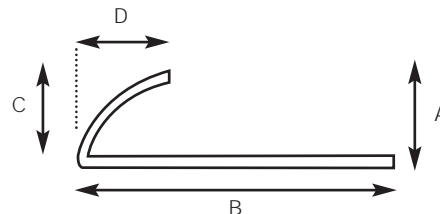

Size	A	B	C	D
6mm	27mm	6.8mm	4mm	
8mm	27mm	8.8mm	5mm	
10mm	27mm	10.8mm	6mm	
12mm	27mm	12.8mm	7mm	

DIY/TRADE

## S/Steel Square Edge Trim x 2.5metre

Colour	6mm Code	8mm Code	10mm Code	12mm Code	Pack Qty	Price List Page
Stainless Steel (304 Grade)	SRE406	SRE408	SRE410	SRE412	20	
Stainless Steel (316L Grade)	SRE1606	SRE1608	SRE1610	SRE1612	20	



External Corner Trim - Horizontal



External Corner Trim - Vertical



Finishing Trim

- Quadrant finish for tile protection.
- Support leg for extra strength and durability.
- Creates an elegant look.
- Commercial application in high traffic areas. Such as Commercial shopping centres.
- Available in a large range of anodised and power coated colours (customised colours available on request).

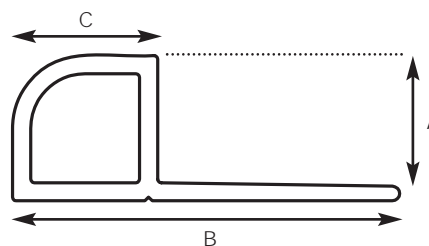

Size	A	B	C
6.5mm	28mm	8mm	
8.5mm	30mm	10mm	
10.5mm	32mm	12mm	
12.5mm	34mm	14mm	

DIY/TRADE

## Aluminium Round Corner x 2.5metre

Colour	6mm Code	8mm Code	10mm Code	12mm Code	Pack Qty	Price List Page
Matt Silver	ACE25.6MS	ACE25.8MS	ACE25.10MS	ACE25.12MS	20	
Bright Silver	ACE25.6BS	ACE25.8BS	ACE25.10BS	ACE25.12BS	20	
Bright Gold	ACE25.6BG	ACE25.8BG	ACE25.10BG	ACE25.12BG	20	
White	ACE25.6W	ACE25.8W	ACE25.10W	ACE25.12W	20	

# ALUMINIUM/PVC SQUARE EDGE TRIM



External Corner Trim - Horizontal



Corner Trim - Vertical

Transition

Finishing Trim

- Square Finish Trim for tile protection.
- Decorative trim to create an elegant look Ideal for:
  - ✓ External Corners both vertical and horizontal
  - ✓ Transition between carpet and tile
  - ✓ Finishing Trim on a vertical wall
- Comes in Range of anodised or powder coated colours.
- Available in PVCU.

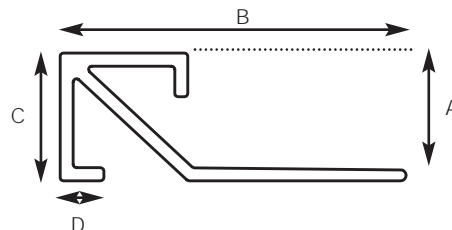

Size A	B	C	D
4.5mm	25mm	5.7mm	1.5mm
6.5mm	27mm	7.7mm	3mm
8.5mm	29mm	9.7mm	3mm
10.5mm	31mm	11.7mm	3mm
12.5mm	33mm	13.7mm	3mm

**DIY/TRADE**

Alum. Square Edge Trim	4mm	6mm	8mm	10mm	12mm	Pack Qty	Price List Page
Colour	Code	Code	Code	Code	Code		

**2.5 METRE LENGTHS**

Matt Silver		ASQE25.4MS	ASQE25.6MS	ASQE25.8MS	ASQE25.10MS	ASQE25.12MS	20
Bright Silver		ASQE25.4BS	ASQE25.6BS	ASQE25.8BS	ASQE25.10BS	ASQE25.12BS	20
Bright Gold		ASQE25.4BG	ASQE25.6BG	ASQE25.8BG	ASQE25.10BG	ASQE25.12BG	20
Matt Black		ASQE25.4MBL	ASQE25.6MBL	ASQE25.8MBL	ASQE25.10MBL	-	20
Matt Bronze		ASQE25.4MBR	ASQE25.6MBR	ASQE25.8MBR	ASQE25.10MBR	-	20
White		ASQE25.4W	ASQE25.6W	ASQE25.8W	ASQE25.10W	ASQE25.12W	20

**3 METRE LENGTHS**

Bright Silver		-	ASQE3.6BS	ASQE3.8BS	ASQE3.10BS	ASQE3.12BS	20
---------------	--	---	-----------	-----------	------------	------------	----



External Corner Trim - Vertical

See diagram and specifications above.

Size A	B	C	D
4.5mm	25mm	5.7mm	1.5mm
6.5mm	27mm	7.7mm	3mm
8.5mm	29mm	9.7mm	3mm
10.5mm	31mm	11.7mm	3mm
12.5mm	33mm	13.7mm	3mm

**DIY/TRADE**

PVC Square Edge Trim	6mm	8mm	10mm	Pack Qty	Price List Page
Colour	Code	Code	Code		

**2.5 METRE LENGTHS**

White		TSQ625W	TSQ825W	TSQ1025W	20
Jasmine		TSQ625J	TSQ825J	TSQ1025J	20
Vanilla		TSQ625V	TSQ825V	TSQ1025V	20



# ALUMINIUM SQUARE EDGE CORNER TRIM & STAINLESS STEEL SQUARE EDGE TRIM



External Corner Trim - Horizontal





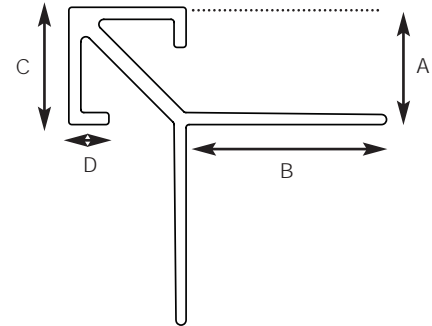

External Corner Trim - Vertical

- Square finish trim for tile protection.
- Decorative trim used to create an elegant look on external corners.
- Can be used both in commercial or domestic applications.
- Available in a range of anodised and powder coated colours. (Customised colours available on request).



Size A	B	C	D
6.5mm	27mm	7.7mm	3mm
8.5mm	29mm	9.7mm	3mm
10.5mm	31mm	11.7mm	3mm
12.5mm	33mm	13.7mm	3mm

DIY/TRADE

Alum. Square Edge Corner X 2.5metre	6mm	8mm	10mm	12mm	Pack Qty	Price List Page
Colour	Code	Code	Code	Code		
Matt Silver 	ACSQ25.6MS	ACSQ25.8MS	ACSQ25.10MS	ACSQ25.12MS	20	
Bright Silver 	ACSQ25.6BS	ACSQ25.8BS	ACSQ25.10BS	ACSQ25.12BS	20	
Bright Gold 	ACSQ25.6BG	ACSQ25.8BG	ACSQ25.10BG	ACSQ25.12BG	20	
White 	ACSQ25.6W	ACSQ25.8W	ACSQ25.10W	ACSQ25.12W	20	



External Corner Trim - Horizontal



Corner Trim - Vertical

Transition

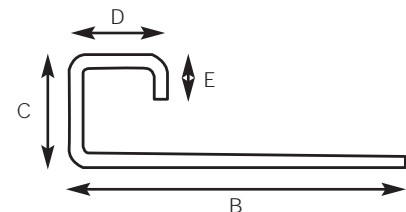

Finishing Trim

- Stainless Steel Square Edge is available in 2.5 metre lengths.
- Creates an elegant decorative modern look to:
  - ✓ Stairs
  - ✓ External Corners both Horizontal and Vertical
  - ✓ Transition between carpet and tile
  - ✓ Finishing trim on a wall
- Available in both 304 grade and Marine 316L stainless steel.



Size A	B	C	D	E
8mm	27mm	8.8mm	8mm	4mm
10mm	27mm	10.8mm	8mm	4mm
12mm	27mm	12.8mm	8mm	4mm

DIY/TRADE

S/Steel Square Edge Trim x 2.5m	8mm	10mm	12mm	Pack Qty	Price List Page
Colour	Code	Code	Code		
Stainless Steel (304 Grade) 	SSQ408	SSQ410	SSQ412	20	
Stainless Steel (316L Grade) 	SSQ1608	SSQ1610	SSQ1612	20	

# ALUMINIUM LISTELLO TRIM



- Ideal for most domestic or commercial applications.
- Available in a range of anodised and powder coated colours (Customised colours available on request).
- Creates a modern contemporary look without the expense of ceramic Listello Tiles.

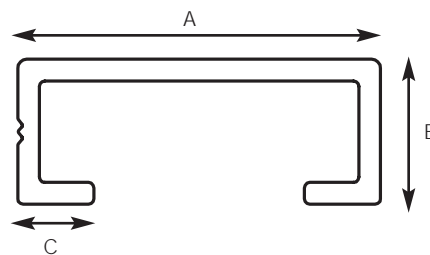

Size A	B	C
10mm	8mm	3.2mm
20mm	8mm	4.2mm

**DIY/TRADE**

Aluminium Flat Listello	10mmX2m	20mmx2m	Pack Qty	Price List Page
Colour	Code	Code		
<b>2 METRE LENGTHS</b>				
Plain	ABT2.10PL	ABT2.20PL	10	
Matt Silver	ABT2.10MS	ABT2.20MS	10	
Bright Silver	ABT2.10BS	ABT2.20BS	10	
Bright Gold	ABT2.10BG	ABT2.20BG	10	
<b>3 METRE LENGTHS</b>				
Bright Silver	ABT3.10BS	ABT3.20BS	10	

# ALUMINIUM L-SHAPE TRIM



External Corner Trim - Horizontal

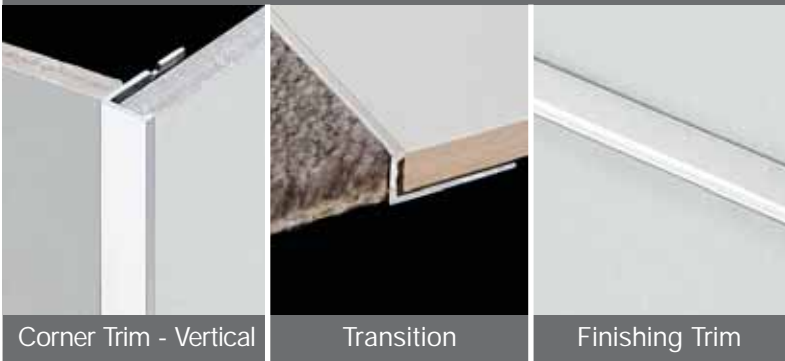

Corner Trim - Vertical

Transition

Finishing Trim

- Aluminium angle for tile edge protection.
- Used where tile meets carpet, wooden floors etc.
- Creates an attractive finish if used on external corners.
- Available in a wide range of sizes. (Powder coated colours available on request).
- 1m lengths also available in anodised colours on request.

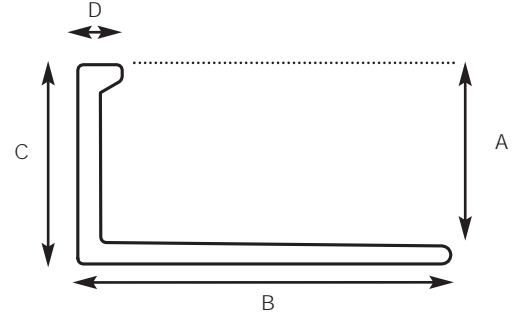

Size A	B	C	D
6mm	21mm	7.2mm	2.5mm
8mm	21mm	9.2mm	2.5mm
9mm	21mm	10.2mm	2.5mm
10mm	21mm	11.2mm	2.5mm
12.5mm	21mm	13.7mm	2.5mm
15mm	21mm	16.2mm	2.5mm
18.5mm	21mm	19.7mm	2.5mm
22mm	21mm	23.2mm	2.5mm

DIY/TRADE

Alum. L Shape Colour	6mm Code	8mm Code	9mm Code	10mm Code	12.5mm Code	15mm Code	18.5mm Code	22mm Code	Pack Qty	Price List Page
----------------------	----------	----------	----------	-----------	-------------	-----------	-------------	-----------	----------	-----------------

## 1 METRE LENGTHS

Plain	ALA1.6	ALA1.8	ALA1.9	ALA1.10	ALA1.12	ALA1.15	ALA1.18	ALA1.22	10
-------	--------	--------	--------	---------	---------	---------	---------	---------	----

## 3 METRE LENGTHS

Plain	ALA3.6	ALA3.8	ALA3.9	ALA3.10	ALA3.12	ALA3.15	ALA3.18	ALA3.22	10
Matt Silver	ALA3.6MS	ALA3.8MS	ALA3.9MS	ALA3.10MS	ALA3.12MS	ALA3.15MS	ALA3.18MS	ALA3.22MS	10
Bright Silver	ALA3.6BS	ALA3.8BS	ALA3.9BS	ALA3.10BS	ALA3.12BS	ALA3.15BS	ALA3.18BS	ALA3.22BS	10
Bright Gold	ALA3.6BG	ALA3.8BG	ALA3.9BG	ALA3.10BG	ALA3.12BG	ALA3.15BG	ALA3.18BG	ALA3.22BG	10
Black	-	ALA3.8BK	-	ALA3.10BK	ALA3.12BK	-	-	-	20
White	-	ALA3.8W	-	ALA3.10W	ALA3.12W	-	-	-	20



Unperforated Aluminium L-Shape Angle x 4m

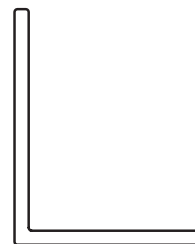

- Various size angles for commonly used self levelling compounds and screeds.
- Other sizes and lengths available on request.

DIY/TRADE

Unperforated Colour	20mm x 12mm x 1.5mm x 4m	20mm x 25mm x 1.5mm x 4m	20mm x 25mm x 3mm x 4m	40mm x 25mm x 1.5mm x 4m	40mm x 25mm x 3mm x 4m	Pack Qty	Price List Page
Plain	PAA4.2012/1.5	PAA4.2025/1.5	PAA4.20253	PAA4.4025/1.5	PAA4.40253		
Gold	-	PAA4.2025G	-	-	-		

# BRASS L-SHAPE TRIM



External Corner Trim - Horizontal

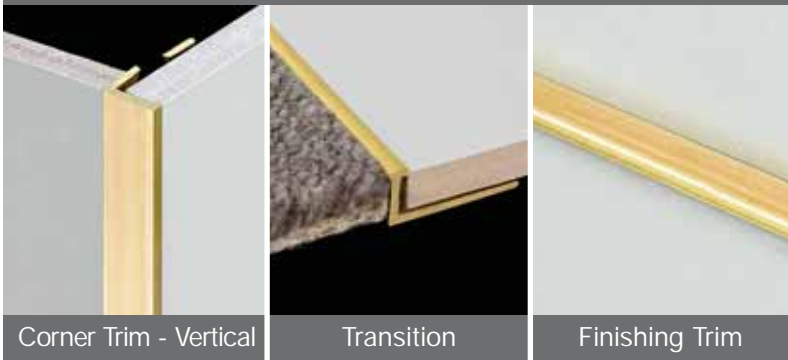

Corner Trim - Vertical

Transition

Finishing Trim

- Brass angle for tile edge protection.
- Used where tile meets carpet, wooden floors etc.
- Creates an attractive finish if used on external corners.
- Available in a wide range of sizes. (Powder coated colours available on request).
- 1m lengths ideal for standard doorways.

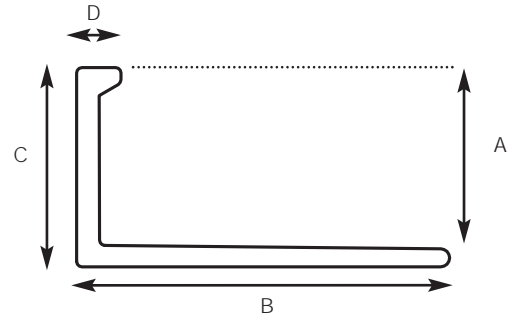

Size A	B	C	D
6mm	21mm	7.3mm	2.5mm
8mm	21mm	9.3mm	2.5mm
9mm	21mm	10.3mm	2.5mm
10mm	21mm	11.3mm	2.5mm
12.5mm	21mm	14.1mm	2.5mm
15mm	21mm	16.6mm	2.5mm
18.5mm	21mm	20.1mm	2.5mm
22mm	21mm	24.1mm	2.5mm

**DIY/TRADE**

Brass L Shape	8mm	10mm	12.5mm	15mm	18.5mm	22mm	Pack Qty	Price List Page
Colour	Code	Code	Code	Code	Code	Code		

**1 METRE LENGTHS**

Plain		PMB1.8	PMB1.10	PMB1.12.5	PMB1.15	PMB1.18.5	PMB1.22	10
-------	--	--------	---------	-----------	---------	-----------	---------	----

**3 METRE LENGTHS**

Plain		PMB3.8	PMB3.10	PMB3.12.5	PMB3.15	PMB3.18.5	PMB3.22	10
-------	--	--------	---------	-----------	---------	-----------	---------	----

# STAINLESS STEEL L-SHAPE TRIM



External Corner Trim - Horizontal

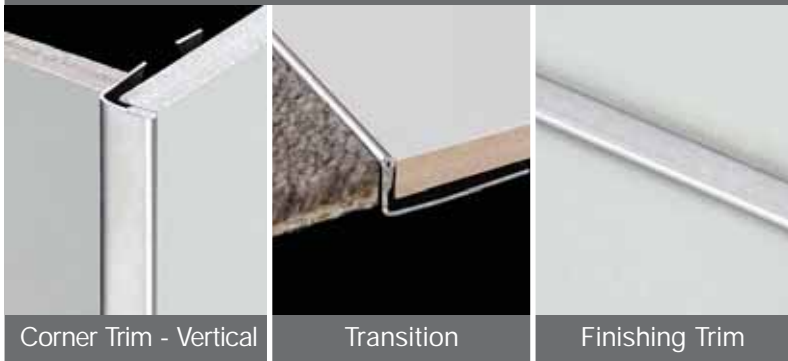

Corner Trim - Vertical

Transition

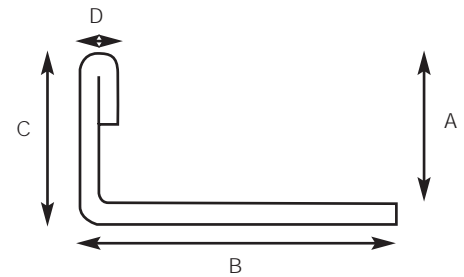

Finishing Trim

- Stainless Steel L Shape Angle available in 3 metre lengths.
- Creates an elegant decorative finish for:
  - ✓ Stairs
  - ✓ External corners both horizontal and vertical
  - ✓ Transition between carpet and tile
  - ✓ Finishing trim on a wall
- Available in both the 304 grade and Marine 316L stainless steel.
- Available in 4 sizes.



Size A	B	C	D
8mm	27mm	8.8mm	2mm
10mm	27mm	10.8mm	2mm
12mm	27mm	12.8mm	2mm
22mm	27mm	22.8mm	2mm

**DIY/TRADE**

S/Steel L-Shape Trim x 3metre	8mm	10mm	12mm	22mm	Pack	Price List
Colour	Code	Code	Code	Code	Qty	Page
Stainless Steel (304 Grade) 	SSE408	SSE410	SSE412	SSE422	20	
Stainless Steel (316L Grade) 	SSE1608	SSE1610	SSE1612	SSE1622	20	

Not recommended for external use.

# ALUMINIUM TRANSITION EDGE TRIM



Transition

- Transition step edge available in 5 sizes and 3 metre lengths.
- 30 degree incline allows for a gradual transition from either concrete, wood floor or vinyl to protect the edge of the tile.
- Ideal for domestic or commercial application.
- Available in 5 different sizes and 3 different colours. (Customised colours are available on request).
- Profiles 12.5mm and larger have a support leg for extra strength.

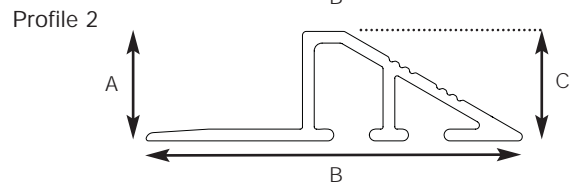
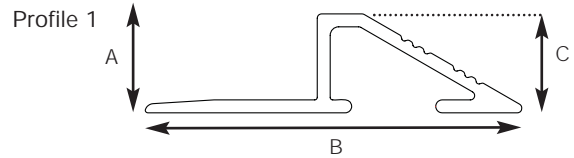

	Size A	B	C	D
Profile 1	8mm	40mm	5.5mm	20mm
	10mm	42mm	5.5mm	23.7mm
Profile 2	12.5mm	48mm	5.5mm	28mm
	16mm	54mm	5.5mm	34mm
	18.5mm	58mm	5.5mm	38.5mm

**DIY/TRADE**

Alum. Transition Edge Colour	8mm Code	10mm Code	12mm Code	16mm Code	18mm Code	Pack Qty	Price List Page
------------------------------	----------	-----------	-----------	-----------	-----------	----------	-----------------

## 1 METRE LENGTHS

Plain	ATSE1.8	ATSE1.10	ATSE1.12	ATSE1.16	ATSE1.18	10	
-------	---------	----------	----------	----------	----------	----	--

## 3 METRE LENGTHS

Plain	ATSE3.8	ATSE3.10	ATSE3.12	ATSE3.16	ATSE3.18	10	
Bright Silver	ATSE3.8BS	ATSE3.10BS	ATSE3.12BS	ATSE3.16BS	ATSE3.18BS	10	
Matt Silver	ATSE3.8MS	ATSE3.10MS	ATSE3.12MS	ATSE3.16MS	ATSE3.18MS	10	

# ALUMINIUM STEP EDGE TRIM & ALUMINIUM CARPET TRIM



Step Edge

- Tile in Safety Step Edge Trim.
- Ideal for commercial application.
- Available in a range in a ranged of anodised and powder coated colours (Customised colours are available on request).
- Rippled surface for extra grip.

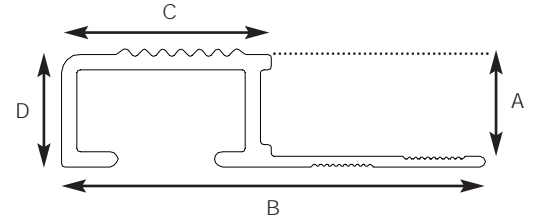

Size A	B	C	D
8mm	41mm	20mm	9mm
10mm	41mm	20mm	11mm
12.5mm	41mm	20mm	14mm

DIY/TRADE

Alum. Step Edge x 3metre	8mm	10mm	12.5mm	Pack	Price List
Colour	Code	Code	Code	Qty	Page
Plain	ASE3.8	ASE3.10	ASE3.12	10	
Bright Silver	ASE3.8BS	ASE3.10BS	ASE3.12BS	10	
Matt Silver	ASE3.8MS	ASE3.10MS	ASE3.12MS	10	
Bright Bronze	ASE3.8BR	ASE3.10BR	ASE3.12BR	10	



Carpet Tile Trim

- Aluminium Rippled Carpet Trim.
- Designed to finish between carpet and tiles. (Includes fixing nails).
- Protects carpet and tile edge.
- Available in anodised gold or plain aluminium.

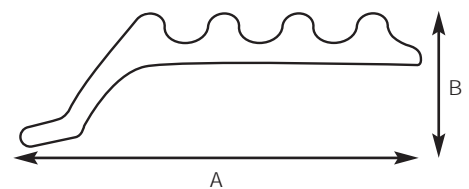

Size A	B
30mm	9.2mm

DIY/TRADE

Aluminium All Purpose Carpet Trim	820m	3.29m	Pack	Price List
Colour	Code	Code	Qty	Page
Matt Silver	PACEPL820	PACEPL3.29	10	
Bright Gold	PACEBG820	PACEBG3.29	10	



Cove Trim

- PVC internal cove hides rough edges.
- Creates an easy to clean corner, a perfect alternative to unsightly grout joints.
- Ideal for - tile to laminate or tile to tile applications.
- Available in 9 fashionable colours.

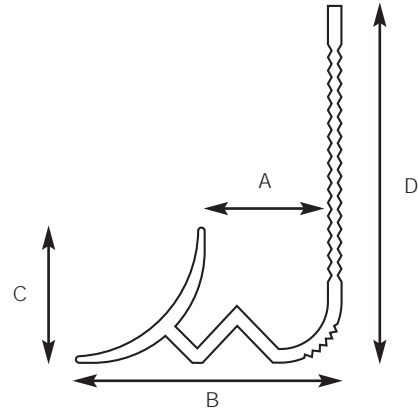

Size	A	B	C	D
6mm		17mm	9.6mm	23.5mm
9mm		20mm	10.3mm	25mm

**DIY/TRADE**

PVC Internal Cove x 2.5metre		6mm	9mm	Pack	Price List
Colour		Code	Code	Qty	Page
White		IC625W	IC925W	20	
Ivory		IC625IY	IC925IY	20	
Vanilla		IC625V	IC925V	20	
Apricot		IC625A	IC925A	20	
Peach		IC625P	IC925P	20	
Beige		IC625BE	IC925BE	20	
Grey		IC625GY	IC925GY	20	
Green		IC625GN	IC925GN	20	
Black		IC625BK	IC925BK	20	



# ALUMINIUM COVE TRIM



Cove Trim

- Cove trim for wall and floor tiles.
- Creates a smooth transition between wall and floor.
- 25.4mm radius for easy cleaning.  
(Conforms with the Australian Standards for hygiene in kitchens and toilets).
- Available in a range of anodised and powder coated colours. (Customised colours are available on request).

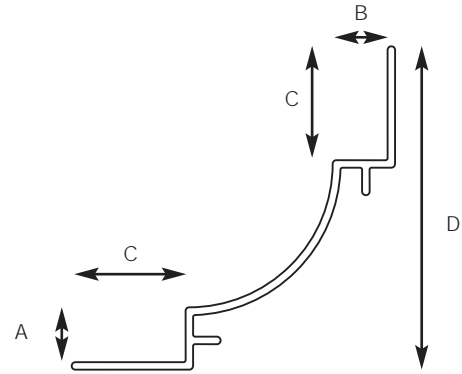

Size A	B	C	D
8mm	10mm	22mm	60mm
10mm	10mm	22mm	60mm

**TRADE**

Alum. Cove Trim	10mm x 8mm x 3.6m	10mm x 10mm x 3.6m	Pack Qty	Price List Page
Colour	Code	Code		
Plain	PACT36PL10X8	PACT36PL10X10	10	
Matt Silver	PACT36MS10X8	PACT36MS10X10	10	
Bright Silver	PACT36BS10X8	PACT36BS10X10	10	
Bright Gold	PACT36BG10X8	PACT36BG10X10	10	
Grey	PACT36G10X8	PACT36G10X10	10	
Black	PACT36BL10X8	PACT36BL10X10	10	
White	PACT36W10X8	PACT36W10X10	10	
Vanilla	PACT36V10X8	PACT36V10X10	10	
Ivory	PACT36IY10X8	PACT36IY10X10	10	
Beige	PACT36BE10X8	PACT36BE10X10	10	
Terracotta	PACT36TE10X8	PACT36TE10X10	10	
Green	PACT36GR10X8	PACT36GR10X10	10	















External Corner Trim



Internal Corner Trim

- Internal and External Corners to suit both the 10 x 8 cove and the 10 x 10 cove.
- Available in a range of anodised and powder coated colours. (Customised colours available on requested).

**TRADE**

Alum. Cove Corner	EXTERNAL		INTERNAL		Pack Qty	Price List Page
	10mm x 8mm Code	10mm x 10mm Code	10mm x 8mm Code	10mm x 10mm Code		
Plain 	PAECPL10X8	PAECPL10X10	PAICPL10X8	PAICPL10X10	5	
Matt Silver 	PAECMS10X8	PAECMS10X10	PAICMS10X8	PAICMS10X10	5	
Bright Silver 	PAECBS10X8	PAECBS10X10	PAICBS10X8	PAICBS10X10	5	
Bright Gold 	PAECBG10X8	PAECBG10X10	PAICBG10X8	PAICBG10X10	5	
Grey 	PAECG10X8	PAECG10X10	PAICG10X8	PAICG10X10	5	
Black 	PAECBL10X8	PAECBL10X10	PAICBL10X8	PAICBL10X10	5	
White 	PAECW10X8	PAECW10X10	PAICW10X8	PAICW10X10	5	
Vanilla 	PAECV10X8	PAECV10X10	PAICV10X8	PAICV10X10	5	
Ivory 	PAECIY10X8	PAECIY10X10	PAICIY10X8	PAICIY10X10	5	
Beige 	PAECBE10X8	PAECBE10X10	PAICBE10X8	PAICBE10X10	5	
Terracotta 	PAECTE10X8	PAECTE10X10	PAICTE10X8	PAICTE10X10	5	
Green 	PAECGR10X8	PAECGR10X10	PAICGR10X8	PAICGR10X10	5	

# ALUMINIUM ALL PURPOSE COVE TRIM



Cove Trim

- Cove trim for wall and floor.
- Installed after tiles have been laid.
- 50mm radius for easy cleaning. (Conforms with Australian Standard for hygiene in kitchens and toilets).
- Available in a range of anodised and powder coated colours. (Customised colours are available on request).

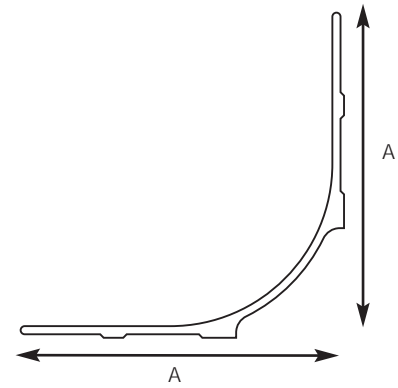

**TRADE**

Alum. All Purpose Cove Trim		3.6metre	Pack	Price List
Colour		Code	Qty	Page
Plain		PAAPC60PL36	10	
Matt Silver		PAAPC60MS36	10	
Bright Silver		PAAPC60BS36	10	
Bright Gold		PAAPC60BG36	10	
Grey		PAAPC60G36	10	
Black		PAAPC60BL36	10	
White		PAAPC60W36	10	
Vanilla		PAAPC60V36	10	
Ivory		PAAPC60IY36	10	
Beige		PAAPC60BE36	10	
Terracotta		PAAPC60TE36	10	
Green		PAAPC60GR36	10	

# PVC MOVEMENT JOINTS & PVC SCREED MOVEMENT JOINT

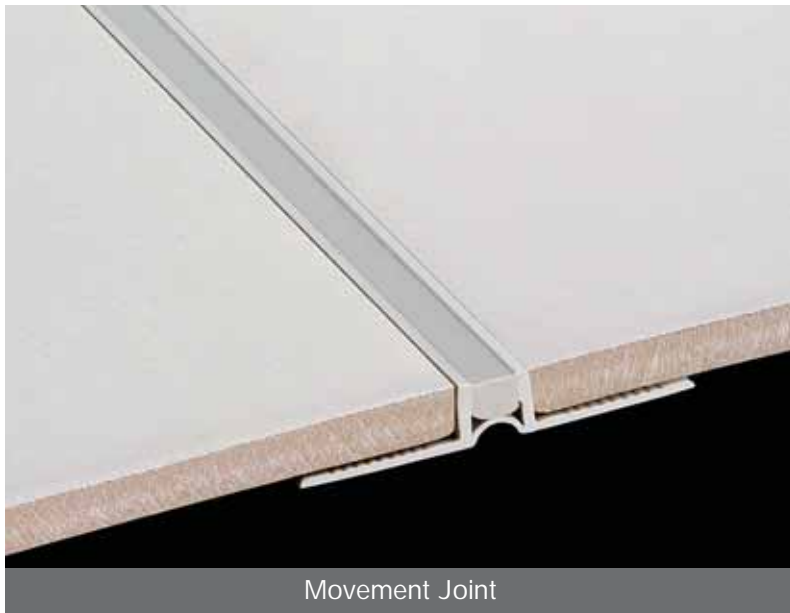

- This is a co extruded PVCU movement joint.
- Allows movement in larger tiled floors.
- Application is for internal use in a domestic area.

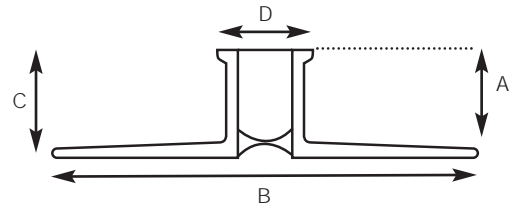

Size A	B	C	D
8mm	48mm	9.2mm	9mm
10mm	48mm	11.2mm	9.5mm
13mm	48mm	13.2mm	9.5mm
30mm	mm	mm	8.6mm

**DIY/TRADE**

PVC Movement Joint x 2.5metre		8mm	10mm	13mm	Pack	Price List
Colour		Code	Code	Code	Qty	Page
Grey		EJT8GREY	EJT10GREY	EJT13GREY	20	
Beige		EJT8BEIGE	EJT10BEIGE	EJT13BEIGE	20	
Black		EJT8BLACK	EJT10BLACK	EJT13BLACK	20	

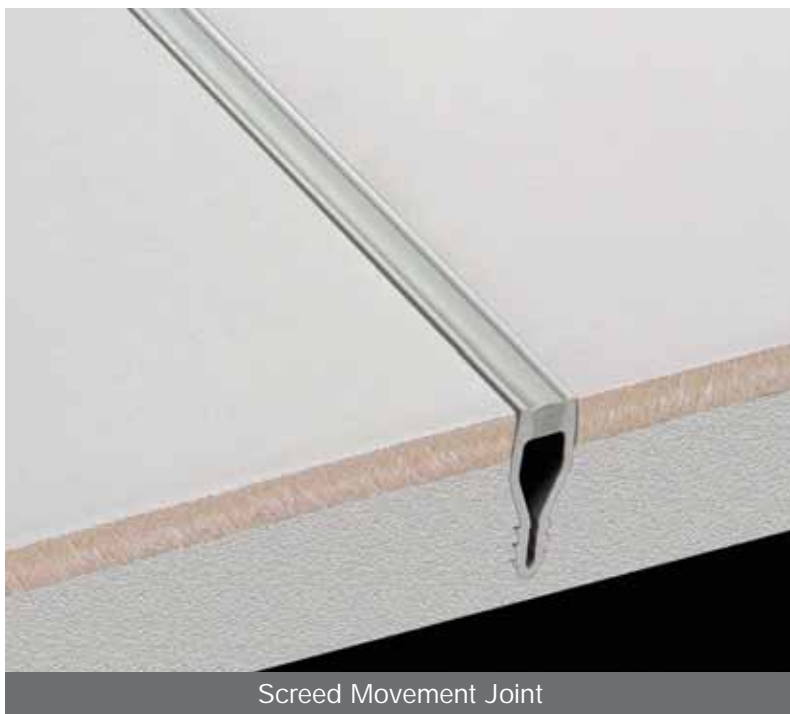

- PVC Screed Joint.
- Available in 2.5 metre length.
- For use in larger tiled areas where screed has been used.
- Available in 3 colours.

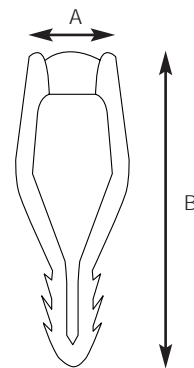

Size A	B
9mm	30mm

**DIY/TRADE**

PVC Screed Movement Joint x 2.5metre		SCREED JOINT	Pack	Price List
Colour		Code	Qty	Page
Grey		EJ30GREY	20	
Beige		EJ30BEIGE	20	
Black		EJ30BLACK	20	

# ALUMINIUM & BRASS MOVEMENT JOINTS

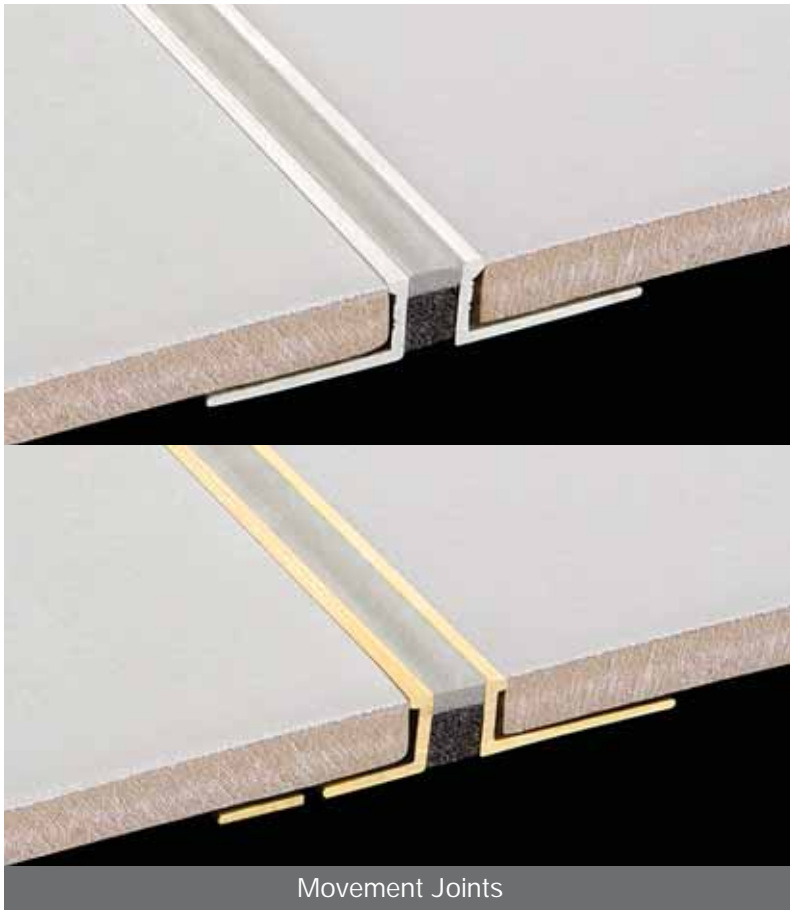

- Prefabricated Movement Joint designed to allow for expansion and contraction of floor tiles.
- Polyurethane insert available in both grey and black. Other colours available on request.
- Shore hardness of 45.
- Aluminium angles protect edge of tiles from damage.
- Installed over construction joints.
- Conforms with Australian Standard AS3958.

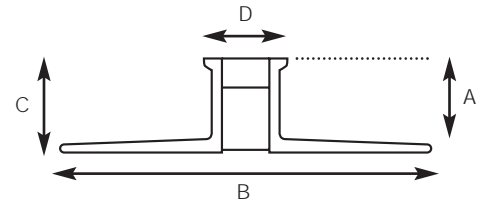

Size A	B	C	D (6mm)	D (10mm)
8mm	52mm	9.2mm	11mm	15mm
10mm	52mm	11.2mm	11mm	15mm
12.5mm	52mm	13.7mm	11mm	15mm
15mm	52mm	16.2mm	11mm	15mm
18.5mm	52mm	19.7mm	11mm	15mm
22mm	52mm	22.5mm	11mm	15mm

Movement Joints

**TRADE**

Movement Joint x 3metre Colour	8mm Code	10mm Code	12mm Code	15mm Code	18mm Code	22mm Code	Pack Qty	Price List Page
<b>ALUMINIUM</b>								
<b>6MM WIDE INSERT</b>								
Grey	PACG3A8X6G	PACG3A10X6G	PACG3A12X6G	PACG3A15X6G	PACG3A18X6G	PACG3A22X6G	10	
Black	PACG3A8X6BL	PACG3A10X6BL	PACG3A12X6BL	PACG3A15X6BL	PACG3A18X6BL	PACG3A22X6BL	10	
<b>10MM WIDE INSERT</b>								
Grey	PACG3A8X10G	PACG3A10X10G	PACG3A12X10G	PACG3A15X10G	PACG3A18X10G	PACG3A22X10G	10	
Black	PACG3A8X10BL	PACG3A10X10BL	PACG3A12X10BL	PACG3A15X10BL	PACG3A18X10BL	PACG3A22X10BL	10	
<b>BRASS</b>								
<b>6MM WIDE INSERT</b>								
Grey	PACG3B8X6G	PACG3B10X6G	PACG3B12X6G	PACG3B15X6G	PACG3B18X6G	PACG3B22X6G	10	
Black	PACG3B8X6BL	PACG3B10X6BL	PACG3B12X6BL	PACG3B15X6BL	PACG3B18X6BL	PACG3B22X6BL	10	
<b>10MM WIDE INSERT</b>								
Grey	PACG3B8X10G	PACG3B10X10G	PACG3B12X10G	PACG3B15X10G	PACG3B18X10G	PACG3B22X10G	10	
Black	PACG3B8X10BL	PACG3B10X10BL	PACG3B12X10BL	PACG3B15X10BL	PACG3B18X10BL	PACG3B22X10BL	10	

# STAINLESS STEEL MOVEMENT JOINTS



Movement Joint

- Prefabricated Movement Joint allows for the expansion and contraction of floor tiles.
- Polyurethane insert comes in grey and black. Other colours are available on request.
- Shore Hardness of 45.
- Stainless Steel Angle grade 304 has been used.
- Marine Grade 316L is also available on request.
- Stainless Steel angles protects the edge of tiles against damage.

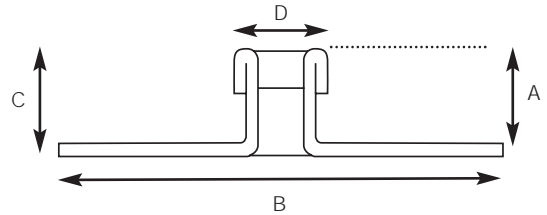

Size A	B	C	D (6mm)	D (10mm)
8mm	52mm	9.2mm	10mm	14mm
10mm	52mm	11.2mm	10mm	14mm
12mm	52mm	13.7mm	10mm	14mm

**TRADE**

## S/Steel Movement Joint x 3metre

Colour	6mm Code	10mm Code	Pack Qty	Price List Page
<b>8MM</b>				
Grey	CGE3S48X6G	CGE3S48X10G	10	
Black	CGE3S48X6BL	CGE3S48X10BL	10	
<b>10MM</b>				
Grey	CGE3S410X6G	CGE3S410X10G	10	
Black	CGE3S410X6BL	CGE3S410X10BL	10	
<b>12MM</b>				
Grey	CGE3S412X6G	CGE3S412X10G	10	
Black	CGE3S412X6BL	CGE3S412X10BL	10	

# TRIMS MERCHANDISING MATERIAL



DTA offer our resellers a number of versatile display options. We have display stands that are suitable for wall mounting, or floor display. Regardless of the size of your retail area, a DTA Trim stand is the best way to display and maintain stock levels of your range of DTA Trims. A DTA Trim Stand enables easy customer comparison and selection of the best trim for the project. In larger stores, trims can be segmented and displayed on multiple stands, allowing separate display of metals and PVC. Please call your DTA representative to discuss the most suitable package for your retail needs.



Code: PBAS3

## Angle Merchandising Stand 3m

Pk Qty: 1 PL Pg:

DISPLAY

- Neatly and efficiently displays 3 metre metal trims in stores.
- Can be individually tailored to suit store requirements.



Code: G003

## DTA Trim Merchandising Stand

Pk Qty: 1 PL Pg:

DISPLAY

- Neatly and efficiently displays PVC and metal trims in stores.
- Can be individually tailored to suit store requirements.



Code: G004

## DTA Trim Merchandising Stand

Pk Qty: 1 PL Pg:

DISPLAY

- Neatly and efficiently displays PVC and metal trims in stores.
- Can be individually tailored to suit store requirements.



Code: PBAS1

## Angle Merchandising Stand 1m

Pk Qty: 1 PL Pg:

DISPLAY

- Neatly and efficiently displays 1 metre metal trims in stores.
- Can be individually tailored to suit store requirements.



***The Choice of Professionals***

## **Warehouse Locations**

### **Head Office – VICTORIA**

P.O. Box 318, Patterson Lakes 3197  
ABN 26 007 291 054

6 Ashley Park Drive, Chelsea Heights 3196

Phone 03 9781 9777  
Fax 03 9781 9788  
E-mail [sales@dta-aus.com.au](mailto:sales@dta-aus.com.au)  
[www.dta-aus.com.au](http://www.dta-aus.com.au)

### **NEW SOUTH WALES**

54 Topham Road, Smeaton Grange 2567

Phone 1800 505 045  
Fax 1800 792 287  
E-mail [dtansw@dta-aus.com.au](mailto:dtansw@dta-aus.com.au)

### **QUEENSLAND**

23 Lisgar Street, Virginia 4014

Phone 07 3865 7591  
Fax 07 3865 7593  
E-mail [dtaqld@dta-aus.com.au](mailto:dtaqld@dta-aus.com.au)

### **WESTERN AUSTRALIA**

Factory 4, 130 Francisco Street, Belmont 6104

Phone 08 9475 0633  
Fax 08 9475 0644  
E-mail [dtawa@dta-aus.com.au](mailto:dtawa@dta-aus.com.au)